

Protecting People, Protecting Productivity



Introducing ATOM,
our NEW RFID Safety Interlock



What is ATOM?

ATOM is a compact and ultra-robust RFID High-Coded Solenoid Interlock that we have added to our ncGard product range.

Suitable for use in applications up to PLe (Cat.4), **ATOM** provides a discreet, easy-to-install solution with monitored inputs and OSSD outputs.



Tools, Fixings and Cables Required
2 x M5 Screws for mounting ATOM Body unit (minimum length 40mm)
2 x M5 Screws for mounting ATOM Actuator unit (minimum length 15mm)
4 x M5 nut / T-nut / Tapped hole (refer to unit drawing for mounting positions)
Thread locking compound (Loctite 243 or equivalent) where appropriate
Driver appropriate to fixing screws used
Spanner appropriate to nuts used (where applicable)
Mechanical Override Driver Bit (provided)
1/4" Driver to suit override driver bit

Connection Options
M12 Quick Disconnects (QD) are supported in single 5 pin, single 8 pin and double 5 pin configurations with the latter for Daisy-Chain applications.
Manual Auxiliary release can be performed with the override driver bit provided (Power to Unlock Only).

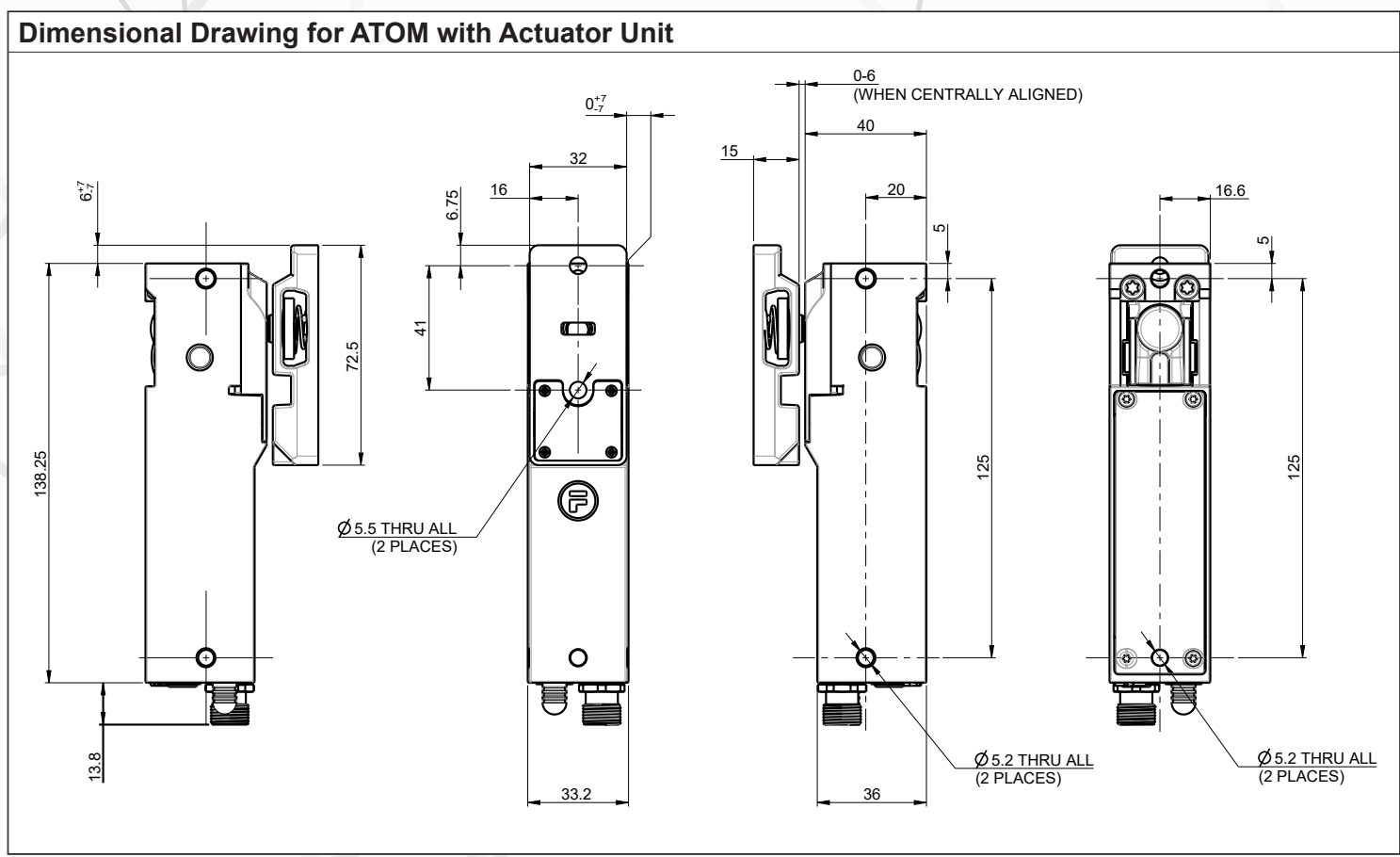

ATOM - High-Coded RFID

ATOM has a High-Coded RFID technology that provides millions of different coding combinations and is classified as 'high' coding by ISO 14119.

The uniquely coded actuator helps to create a tamperproof system that prevents unauthorised access.

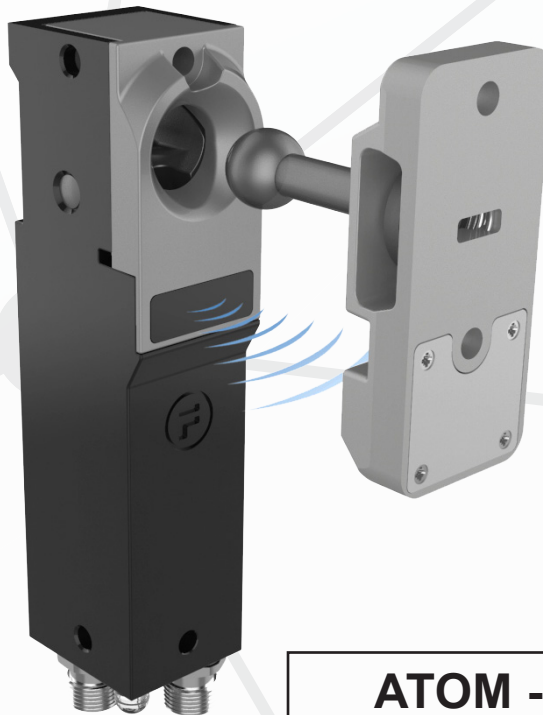

ATOM - OSSD Outputs

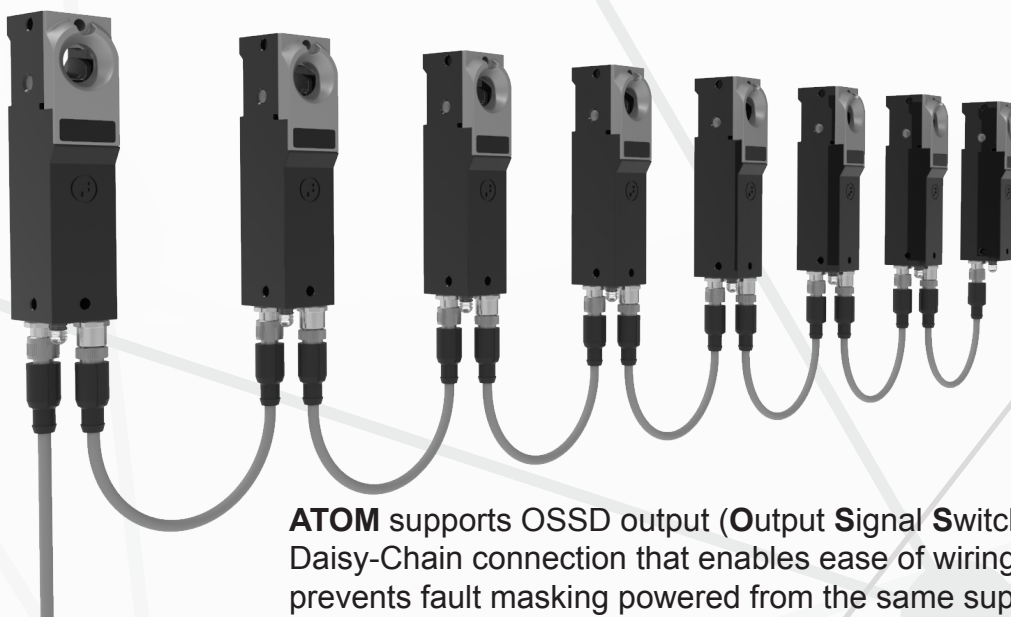

ATOM supports OSSD output (**O**utput **S**ignal **S**witching **D**evice) with Daisy-Chain connection that enables ease of wiring installation and prevents fault masking powered from the same supply. Each **ATOM** unit in series draws current and causes a voltage drop on the power line. For a detailed calculation please see the Voltage Drop Tool on the Fortress website.

ATOM - High Mechanical Misalignment

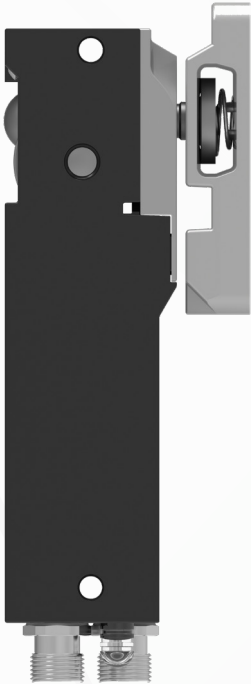

The **ATOM** Actuator can pivot and self-centre to operate under a high degree of misalignment.

High maximum retention force of up to 8kN.

Pivoting mechanism is particularly well suited to small radius hinged doors and hatches.

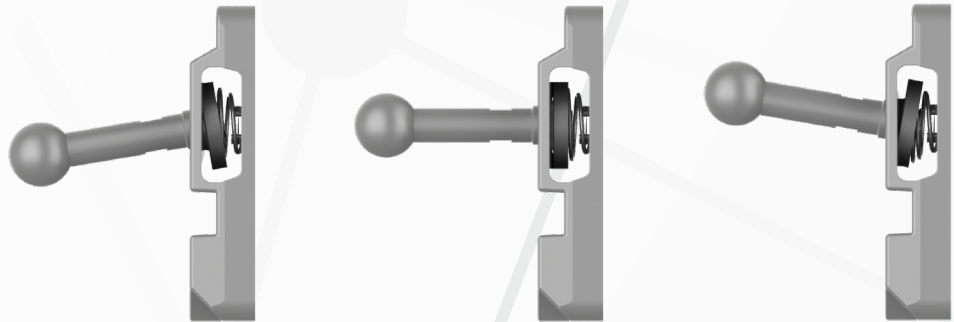

Application Example - ATOM in Action: CNC MACHINE

If a person requires entry to the machine they must press the 'Request to Stop' button.

The **ATOM** will prevent guard doors from opening whilst the machine is still operating during rundown time.

Once the machine has stopped, the **ATOM's** solenoid is energised which breaks the dual safety circuit to prevent unexpected restart.

Opening the guard door disconnects the RFID connection which prevents inadvertent restart.

High-Coded RFID Technology prevents any attempts to manually defeat the unit.

When intervention is complete, closing the machine door will re-establish the safety circuits and providing the solenoid is de-energised, the **ATOM** unit will then relock and allow for machine restart.

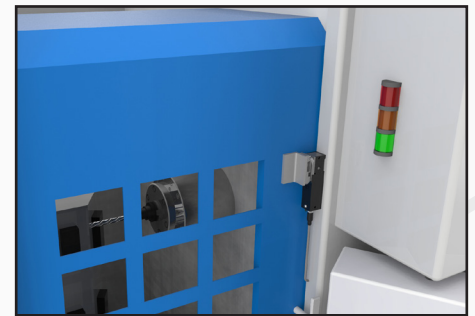

CNC MACHINE

Introducing ATOM, our NEW RFID Safety Interlock

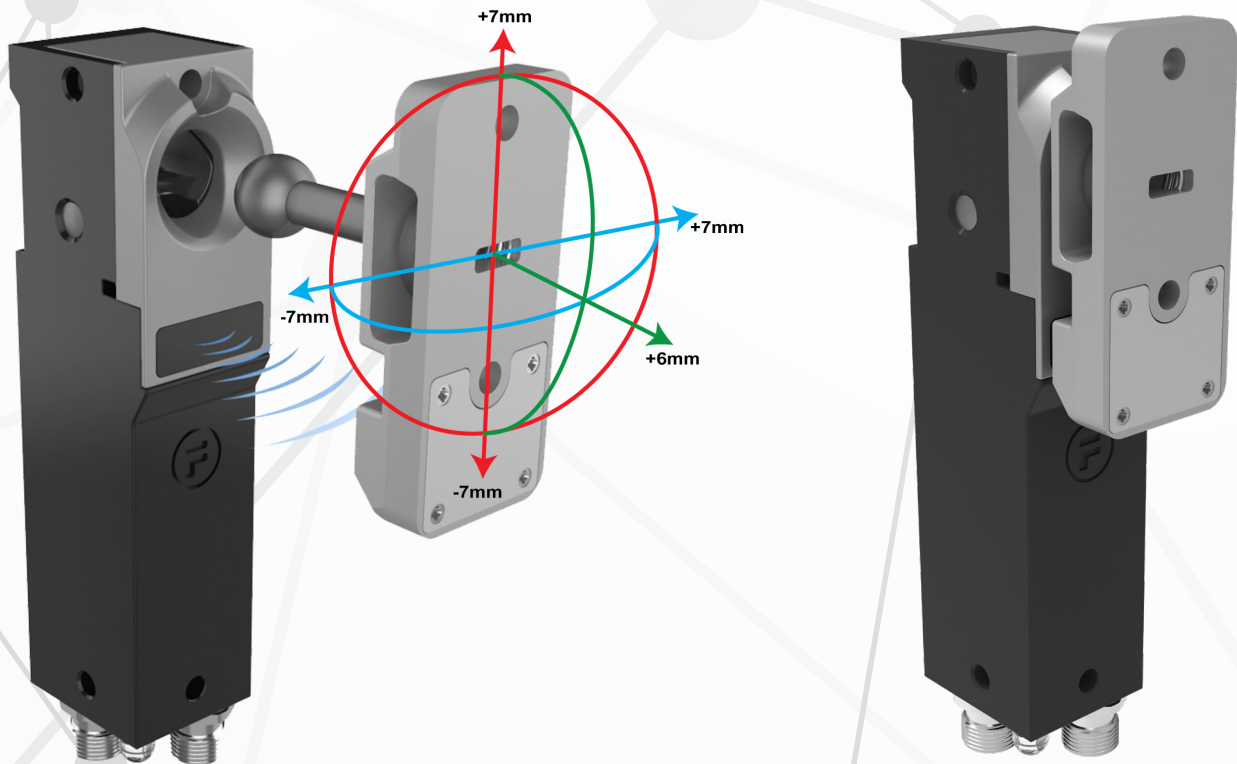



What are the feature and benefits of ATOM?	
Feature	Benefits
Solenoid Controlled Interlock	Access only when you decide
High-Coded RFID	Prevents actuator substitution
Robust Actuator design with high locking and retention force (8kN)	Withstands guard doors being forced open
Ultra compact mounting footprint, easy to mount with 2 x M5 screws	Fits neatly on your aluminium profiles
Safeguarding application up to PLe and SIL3 rating	You can use it on your most dangerous machines
Provides OSSD outputs with Daisy-Chain connection, connects up to 8 ATOMs in series	Reducing your installation costs
High Mechanical Misalignment	Allows for wider guarding positioning
Compact design for installation in discreet locations	Install it out of the way
Sealed to IP65 and IP67	You can use it in harsh environments
TUV Safety Certification Pending	Complete confidence in the product





Protecting People, Protecting Productivity

A HALMA COMPANY



Fortress Interlocks Ltd

-  +44 (0)1902 349000
-  +44 (0)1902 349090
-  sales@fortressinterlocks.com

Fortress Interlocks Europe

-  +31 (0)10 7536060
-  +31 (0)10 7536050
-  europe@fortressinterlocks.com



Fortress Interlocks USA

-  +1 (859) 578 2390
-  +1 (859) 341 2302
-  us@fortressinterlocks.com

Fortress Interlocks Pty Ltd

-  +61 (0)3 9771 5350
-  +61 (0)3 9771 5360
-  australia@fortressinterlocks.com

Fortress Interlocks China

-  +86 (021) 6016 7611
-  china@fortressinterlocks.com

Official Distributor



www.fortressinterlocks.com